

Title: Creating a Project Archive

Product: OrCAD Capture with PSpice and Allegro
 DE CIS with AMS Simulator

Summary: Describes how to create a PSpice Archive
 File with Capture

Author/Date: Wei Ling / 03.08.2009

Table of Contents

1	Introduction	2
2	Demo Project	2
3	Archive the Project	4
4	Create a zip Archive File	6
5	Add additional Files and Directories to the Archive.....	7
6	Bibliography:	8

1 Introduction

When the project manager window is active, you can save a new or existing project, design, or library. You can save the project and all the related files (design, library, output files, and referenced projects) in a different directory and also create a zip file of this directory for archival purposes. You can also specify any additional files or directories that you may want to be archived along with your project files. For example, you can archive external designs, global PSpice model libraries or data sheets.

2 Demo Project

The example circuit we would like to build up is a simple adder. The circuit in the demo project adder.opj is illustrated in the following diagram.

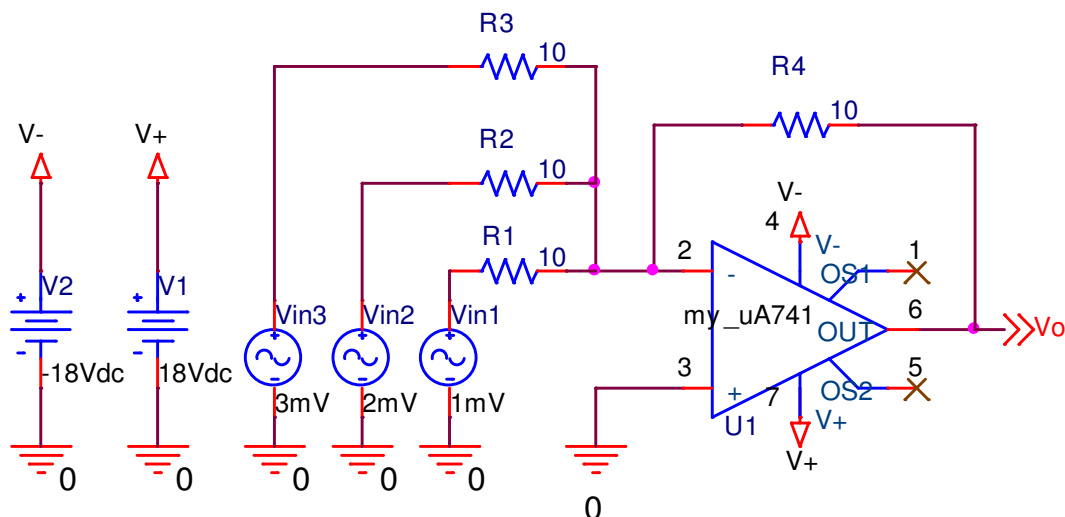

The operational amplifier which we use for the adder is uA741. The output voltage V_o can be calculated with the following function:

$$V_o = -R_4 \cdot \left(\frac{V_{in1}}{R_1} + \frac{V_{in2}}{R_2} + \frac{V_{in3}}{R_3} \right)$$

The frequency for the input voltage sources V_{in1} , V_{in2} and V_{in3} is set to 50Hz. Run the simulation for 100ms, for example, to get 5 signal periods. The output voltage V_o is displayed as follows:

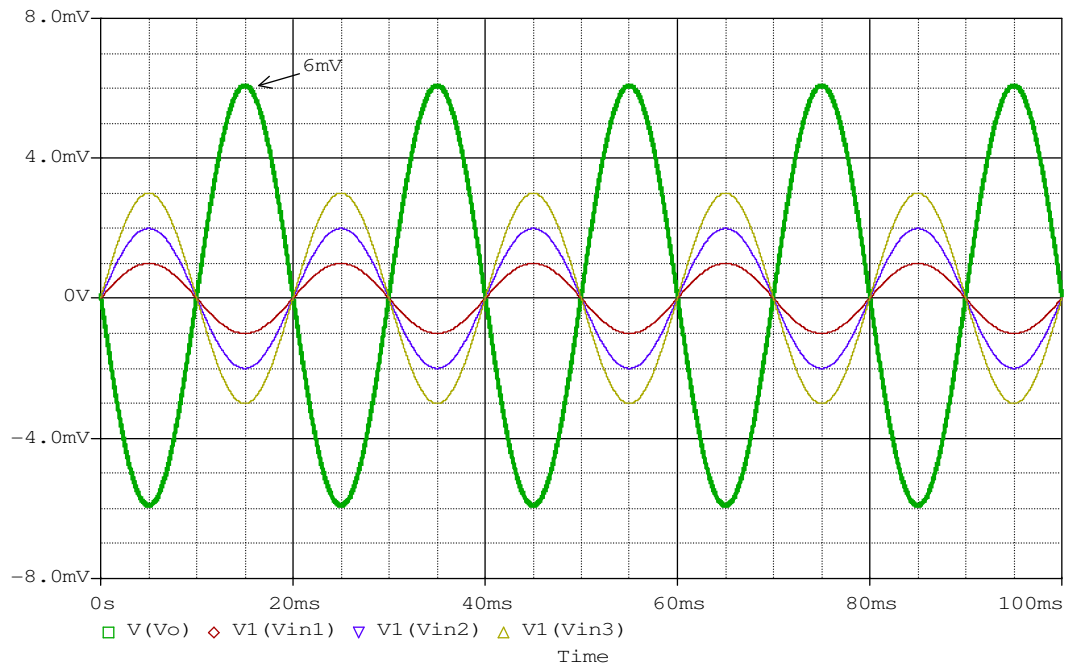

Because $R4 = R1 = R2 = R3$, hence $V_o = - (V_{in1} + V_{in2} + V_{in3})$. In the above diagram you can see that the peak value of V_o is 6mV, which is equal to the negative sum of the minimum amplitudes of V_{in1} , V_{in2} and V_{in3} .

3 Archive the Project

You can save this project and all the related files in a different directory. To do this

1. Make sure that the project manager window is active, the schematic pages and other related files are not open.
2. From the menu bar click **File**→ **Archive Project...**→ The **Archive Project** dialog box appears

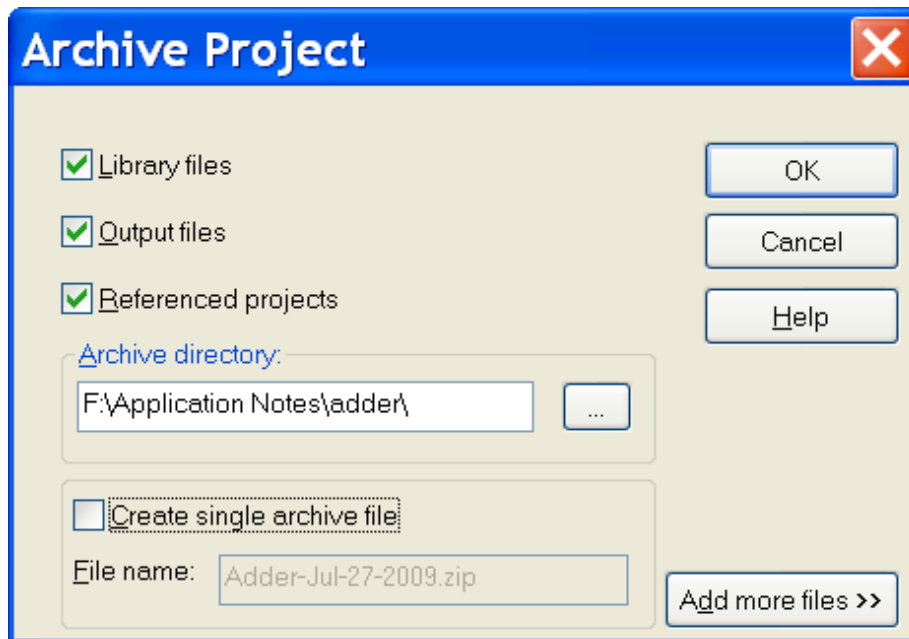

Select the files you want to archive with your project.

If you don't select any of the options (Library files, Output files or Referenced projects), Capture archives by default only your project (.OPJ) and design (.DSN) files.

Note:

For PSpice projects, the simulation profiles and local files (.LIB, .STL, .INC) will all be archived along with the project.

For example, if you have configured the PSpice model library adder.lib (see the following diagram) which contains the PSpice model my_ua741, the adder.lib will be archived along with the project.

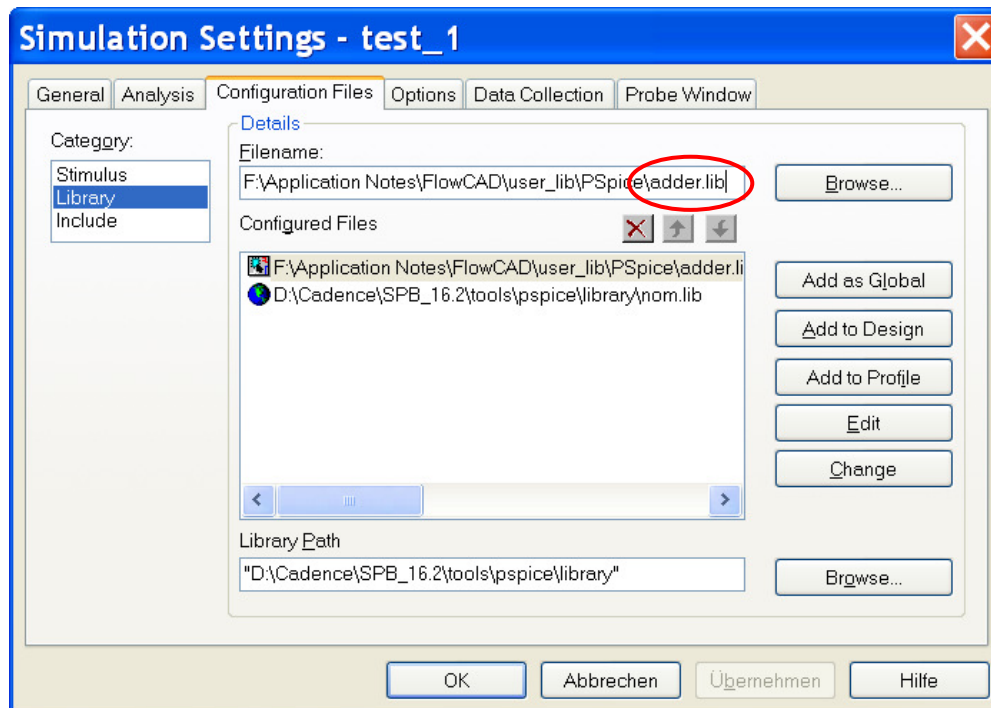

The Output files option also archives simulation output files such as the waveform file (.DAT) and the output file (.OUT) for PSpice projects.

In the field **Archive directory** assign a directory, e.g. F:\Application Notes\adder, to which you will save your files.

Click **OK** in the Archive Project dialog box. Capture archives your project with all the selected files to the specified directory and displays information/errors in the Session Log.

4 Create a zip Archive File

Sometimes you need a single archive file for your project. Using the same processes described in 3 you can select the **Create single archive file** check box to activate the **File name** text box.

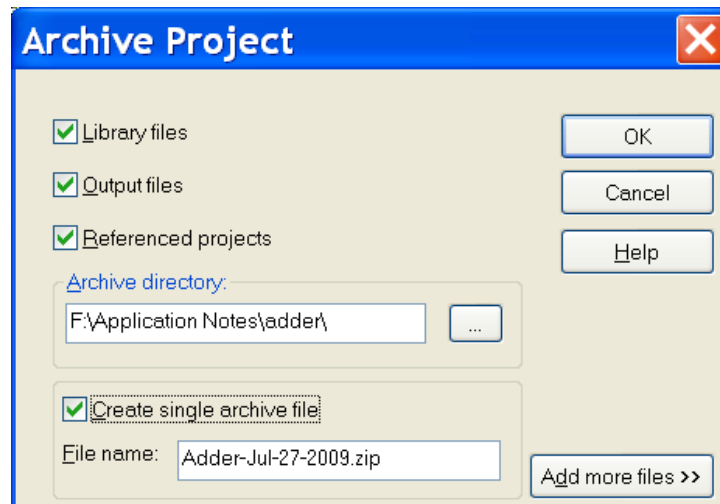

Note:

The default file name for the zip archive file is <projectname-current date>. The file extension (.zip) is automatically added to the zip archive file.

Click OK, Capture zips all the files in the specified directory and generates a zip file with .zip extension. The Session Log displays all the events that occur during the archiving process and report whether the process was completed successfully or with errors.

5 Add additional Files and Directories to the Archive

You can click the button **Add more files** in the **Archive Project** dialog box in order to add more files e.g. data sheets or directories to the archive. The expanded **Archive Project** dialog box is displayed as follows:

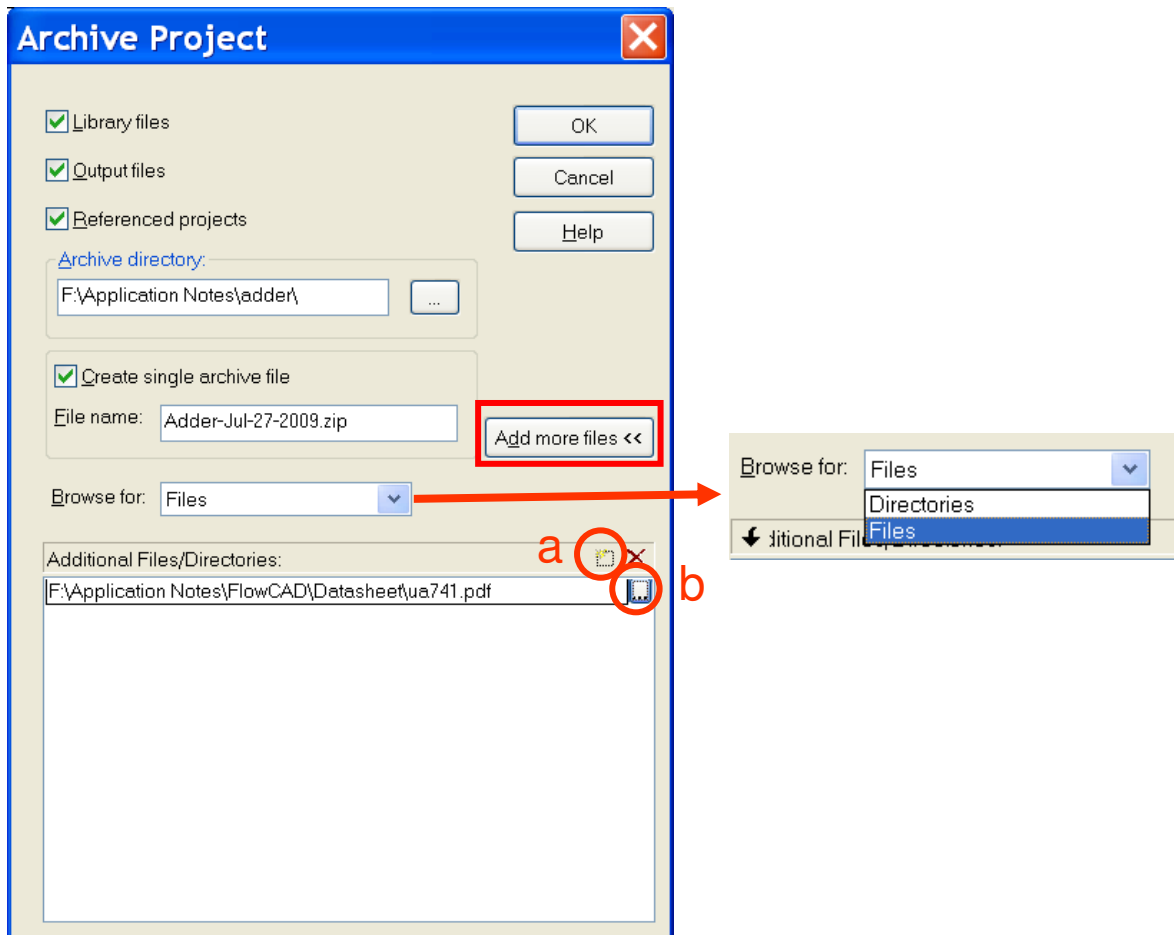

Select an option from the **Browse for** list box. Select the **Directories** option to add directories or the **Files** option to add more files to your archive. As an example we would like to add the data sheet of the operational amplifier ua741 which is used in the adder project.

In the **Browse for** list box select **Files**→

Click the button (in above diagram a) to add additional files→

Click the button (in above diagram b), the **Select Files** window pops up, find the data sheet ua741.pdf and open it→

Click **OK** in the **Archive Project** dialog box. Capture archives your project with all the selected additional files to the specified directory. The current working directory does not change to the newly set archive directory.

Note:

The files and directories you add using the Additional Files/Directories list are added to the archive directory under a separate sub-directory called Additional files.

In the following diagram you will see that the PSpice library adder.lib and the folder Additional Files, which contains the data sheet of ua741, are in the archived directory.

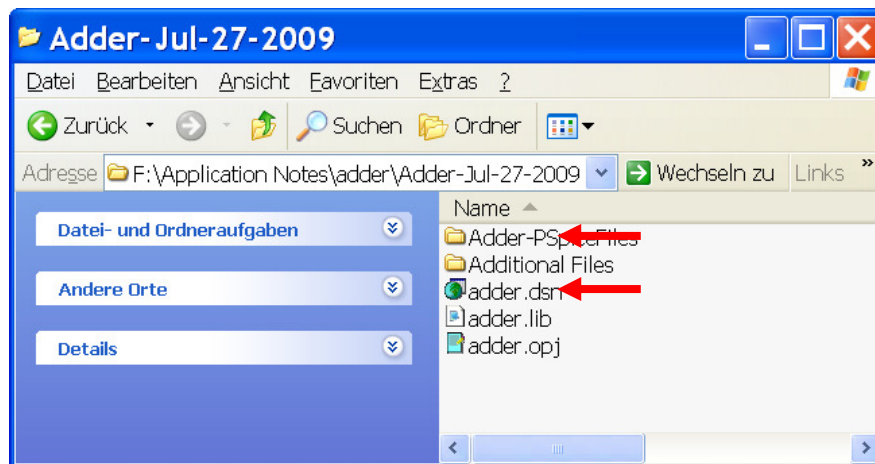

6 Bibliography:

- [1] PSpice User's Guide, Cadence
- [2] OrCAD Capture User's Guide, Cadence